

GRILLI AD OMEGA

Con perno a vite - Modello G-4161

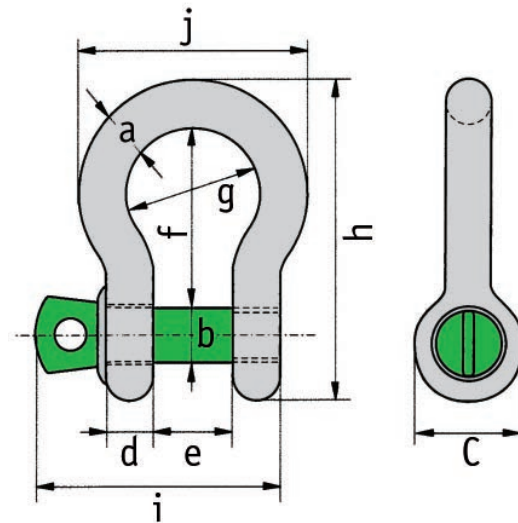

Codice	Portata WLL	Misura	Dimensioni											Peso
			t	inches	a mm	b mm	c mm	d mm	e mm	f mm	g mm	h mm	i mm	
GPV00500-GP	0,5	1/4	7	8	16,5	7	12	29	20	48,5	38	34	4	0,05
GPV00750-GP	0,75	5/16	9	10	20	9	13,5	32	22	56	46,5	40	5	0,1
GPV01000-GP	1	3/8	10	11	22,5	10	17	36,5	26	63,5	54	46	8	0,14
GPV01500-GP	1,5	7/16	11	13	26,5	11	19	43	29	74	59,5	51	11	0,19
GPV02000-GP	2	1/2	13,5	16	34	13	22	51	32	89	73	58	13	0,36
GPV03250-GP	3,25	5/8	16	19	40	16	27	64	43	110	89	75	17	0,63
GPV04750-GP	4,75	3/4	19	22	46	19	31	76	51	129	103	89	19	1,01
GPV06500-GP	6,5	7/8	22	25	52	22	36	83	58	144	119	102	22	1,5
GPV08500-GP	8,5	1	25	28	59	25	43	95	68	164	137	118	25	2,21
GPV09500-GP	9,5	1 1/8	28	32	66	28	47	108	75	185	153	131	27	3,16
GPV12000-GP	12	1 1/4	32	35	72	32	51	115	83	201	170	147	30	4,31
GPV13500-GP	13,5	1 3/8	35	38	80	35	57	133	92	227	186	162	33	5,55
GPV17000-GP	17	1 1/2	38	42	88	38	60	146	99	249	203	175	33	7,43
GPV25000-GP	25	1 3/4	45	50	103	45	74	178	126	300	243	216	33	12,84
GPV35000-GP	35	2	50	57	111	50	83	197	138	331	272	238	33	18,15
GPV42500-GP	42,5	2 1/4	57	65	130	57	95	222	160	377	310	274	33	26,3
GPV55000-GP	55	2 1/2	65	70	145	65	105	260	180	433	344	310	32	37,6

- Acciaio alta resistenza grado 6
- Finitura: zincatura a caldo
- Temperatura di lavoro: -40°C ÷ 200°C
- Coefficiente di sicurezza 6:1
- Conforme alla direttiva macchine 2006/42/CE