



PULEGGE DENTATE "PCB" A BUSSOLA CONICA PER CINGHIE SYNCHROCHAIN "PCB" SYNCHROCHAIN TIMING BELTS PULLEYS FOR TAPER BUSHES

8M

PASSO 8 mm

PER CINGHIE LARGHEZZA 12 mm

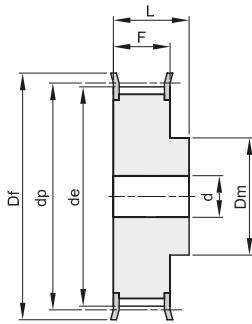

2F

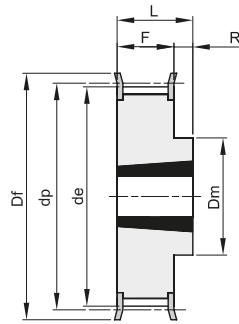

10F

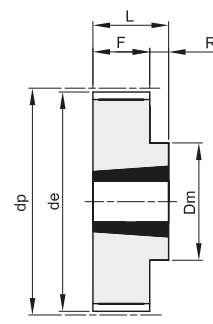

10

Materiale: Acciaio (St)
Materiale: Ghisa (GG)

descrizione	codice	tipo	materiale	denti	buss.	foro max	dp	de	Df	Dm	Di	F	L	R	d	n° flangia	Kg.
8M 22S 12	PCB47012022	2F	St	22			56,02	54,42	60	43		20	30	10	12	308	0,43
TL 8M 25S 12	PCB47012025	10F	St	25	1108	28	63,66	62,06	66	49		20	22	2		310	0,25
TL 8M 28S 12	PCB47012028	10F	St	28	1108	28	71,30	69,70	75	56		20	22	2		312	0,37
TL 8M 30S 12	PCB47012030	10F	St	30	1210	32	76,39	74,79	83	60		20	25	5		314	0,41
TL 8M 32S 12	PCB47012032	10F	St	32	1610	42	81,49	79,89	87	66		20	25	5		315	0,43
TL 8M 34S 12	PCB47012034	10F	St	34	1610	42	86,58	84,98	91	68		20	25	5		316	0,45
TL 8M 36S 12	PCB47012036	10F	St	36	1610	42	91,67	90,07	98	74		20	25	5		319	0,59
TL 8M 38S 12	PCB47012038	10F	St	38	1610	42	96,77	95,17	103	80		20	25	5		320	0,70
TL 8M 40S 12	PCB47012040	10F	St	40	1610	42	101,86	100,26	106	85		20	25	5		321	0,82
TL 8M 45S 12	PCB47012045	10F	St	45	2012	50	114,59	112,99	119	92		20	32	12		325	1,10
TL 8M 48S 12	PCB47012048	10F	St	48	2012	50	122,23	120,63	127	100		20	32	12		327	1,42
TL 8M 50S 12	PCB47012050	10F	St	50	2012	50	127,32	125,72	135	104		20	32	12		328	1,60
TL 8M 56S 12	PCB47012056	10F	St	56	2012	50	142,60	141,00	148	104		20	32	12		333	2,10
TL 8M 60S 12	PCB47012060	10F	St	60	2012	50	152,79	151,19	158	111		20	32	12		335	2,40
TL 8M 64S 12	PCB47012064	10F	St	64	2012	50	162,97	161,37	168	111		20	32	12		338	2,70
TL 8M 75S 12	PCB47012075	10	GG	75	2012	50	190,99	189,39		111		20	32	12			3,70
TL 8M 80S 12	PCB47012080	10	GG	80	2012	50	203,72	202,12		111		20	32	12			4,40
TL 8M 90S 12	PCB47012090	10	GG	90	2012	50	229,18	227,58		111		20	32	12			5,50



PULEGGE DENTATE "PCB" A BUSSOLA CONICA PER CINGHIE SYNCHROCHAIN "PCB" SYNCHROCHAIN TIMING BELTS PULLEYS FOR TAPER BUSHES

8M

PASSO 8 mm

PER CINGHIE LARGHEZZA 21 mm

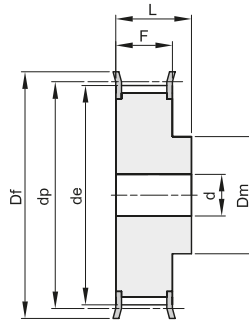

2F

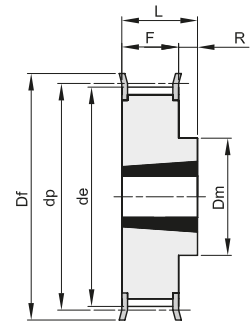

10F

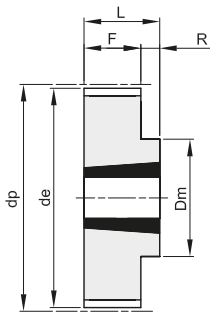

10

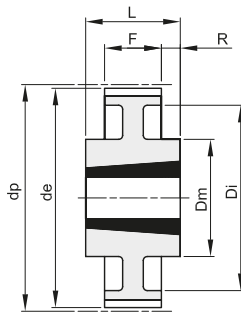

13

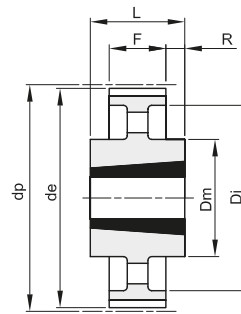

14

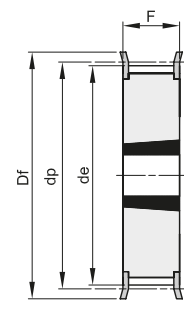

15F

Materiale: Acciaio (St)
Materiale: Ghisa (GG)

descrizione	codice	tipo	materiale	denti	buss.	foro max	dp	de	Df	Dm	Di	F	L	R	d	n° flangia	Kg.
8M 22S 21	PCB47021022	2F	St	22			56,02	54,42	60	43		30	40	10	12	308	0,56
TL 8M 25S 21	PCB47021025	15F	St	25	1108	28	63,66	62,06	66			30				310	0,36
TL 8M 28S 21	PCB47021028	15F	St	28	1210	32	71,30	69,70	75			30				312	0,41
TL 8M 30S 21	PCB47021030	15F	St	30	1210	32	76,39	74,79	83			30				314	0,56
TL 8M 32S 21	PCB47021032	15F	St	32	1610	42	81,49	79,89	87			30				315	0,52
TL 8M 34S 21	PCB47021034	15F	St	34	1610	42	86,58	84,98	91			30				316	0,61
TL 8M 36S 21	PCB47021036	15F	St	36	1610	42	91,67	90,07	98			30				319	0,70
TL 8M 38S 21	PCB47021038	15F	St	38	1610	42	96,77	95,17	103			30				320	0,92
TL 8M 40S 21	PCB47021040	15F	St	40	1610	42	101,86	100,26	106			30				321	1,06
TL 8M 45S 21	PCB47021045	10F	St	45	2012	50	114,59	112,99	119	92		30	32	2		325	1,30
TL 8M 48S 21	PCB47021048	10F	St	48	2012	50	122,23	120,63	127	100		30	32	2		327	1,60
TL 8M 50S 21	PCB47021050	10F	St	50	2012	50	127,32	125,72	135	104		30	32	2		328	1,83
TL 8M 56S 21	PCB47021056	10F	St	56	2012	50	142,60	141,00	148	111		30	32	2		333	2,40
TL 8M 60S 21	PCB47021060	10F	St	60	2517	65	152,79	151,19	158	124		30	45	15		335	3,20
TL 8M 64S 21	PCB47021064	10F	St	64	2517	65	162,97	161,37	168	124		30	45	15		338	3,80
TL 8M 75S 21	PCB47021075	10	GG	75	2517	65	190,99	189,39		124		30	45	15			6,20
TL 8M 80S 21	PCB47021080	10	GG	80	2517	65	203,72	202,12		124		30	45	15			6,00
TL 8M 90S 21	PCB47021090	13	GG	90	2517	65	229,18	227,58		124	198	30	45	7,5			5,40
TL 8M 112S 21	PCB47021112	13	GG	112	2517	65	285,21	283,61		124	253	30	45	7,5			7,40
TL 8M 140S 21	PCB47021140	14	GG	140	3020	75	356,51	354,91		150	324	30	51	10,5			9,00



PULEGGE DENTATE "PCB" A BUSSOLA CONICA PER CINGHIE SYNCHROCHAIN "PCB" SYNCHROCHAIN TIMING BELTS PULLEYS FOR TAPER BUSHES

8M

PASSO 8 mm

PER CINGHIE LARGHEZZA 36 mm

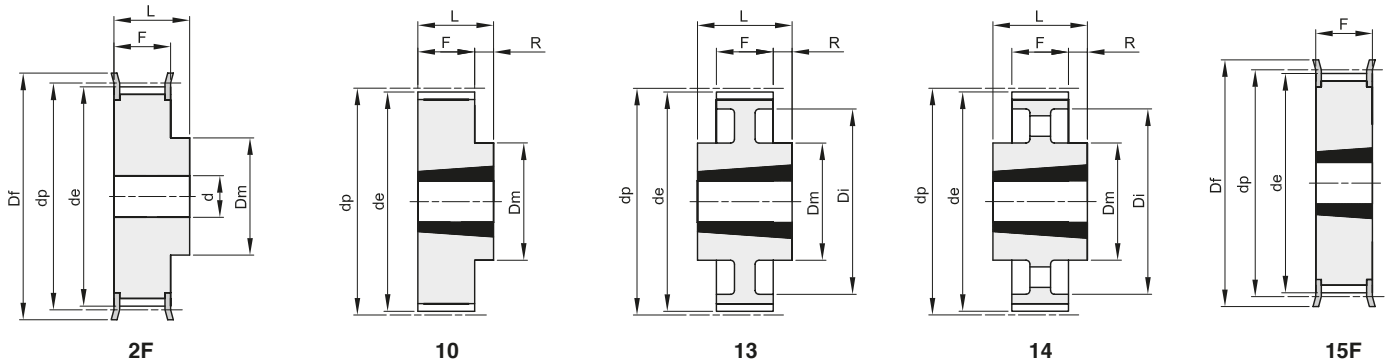

Materiale: Acciaio (St)
Materiale: Ghisa (GG)

descrizione	codice	tipo	materiale	denti	buss.	foro max	dp	de	Df	Dm	Di	F	L	R	d	n° flangia	Kg.
8M 25S 36	PCB47036025	2F	St	25			63,66	62,06	66	49		45	55		12	310	1,40
TL 8M 28S 36	PCB47036028	15F	St	28	1210	32	71,30	69,70	75			45				312	0,64
TL 8M 30S 36	PCB47036030	15F	St	30	1610	42	76,39	74,79	83			45				314	0,59
TL 8M 32S 36	PCB47036032	15F	St	32	1610	42	81,49	79,89	87			45				315	0,79
TL 8M 34S 36	PCB47036034	15F	St	34	1610	42	86,58	84,98	91			45				316	0,63
TL 8M 36S 36	PCB47036036	15F	St	36	1610	42	91,67	90,07	98			45				319	1,15
TL 8M 38S 36	PCB47036038	15F	St	38	1610	42	96,77	95,17	103			45				320	1,39
TL 8M 40S 36	PCB47036040	15F	St	40	2012	50	101,86	100,26	106			45				321	1,34
TL 8M 45S 36	PCB47036045	15F	St	45	2012	50	114,59	112,99	119			45				325	1,87
TL 8M 48S 36	PCB47036048	15F	St	48	2012	50	122,23	120,63	127			45				327	2,20
TL 8M 50S 36	PCB47036050	15F	St	50	2012	50	127,32	125,72	135			45				328	2,70
TL 8M 56S 36	PCB47036056	15F	St	56	2517	65	142,60	141,00	148			45				333	3,00
TL 8M 60S 36	PCB47036060	15F	St	60	2517	65	152,79	151,19	158			45				335	3,80
TL 8M 64S 36	PCB47036064	15F	St	64	2517	65	162,97	161,37	168			45				338	4,50
TL 8M 75S 36	PCB47036075	10	GG	75	3020	75	190,99	189,39		150		45	51	6			6,20
TL 8M 80S 36	PCB47036080	10	GG	80	3020	75	203,72	202,12		150		45	51	6			7,40
TL 8M 90S 36	PCB47036090	13	GG	90	3020	75	229,18	227,58		150	197	45	51	3			7,20
TL 8M 112S 36	PCB47036112	13	GG	112	3020	75	285,21	283,61		150	253	45	51	3			10,40
TL 8M 140S 36	PCB47036140	14	GG	140	3020	75	356,51	354,91		150	324	45	51	3			12,70
TL 8M 168S 36	PCB47036168	14	GG	168	3525	90	427,81	426,21		198	396	45	65	10			21,50
TL 8M 192S 36	PCB47036192	14	GG	192	3525	90	488,92	487,32		198	457	45	65	10			27,00



PULEGGE DENTATE "PCB" A BUSSOLA CONICA PER CINGHIE SYNCHROCHAIN "PCB" SYNCHROCHAIN TIMING BELTS PULLEYS FOR TAPER BUSHES

8M

PASSO 8 mm

PER CINGHIE LARGHEZZA 62 mm

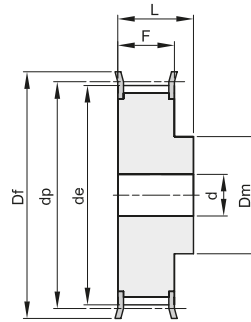

2F

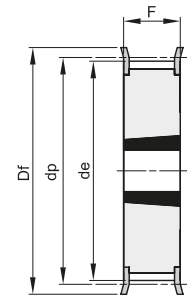

15F

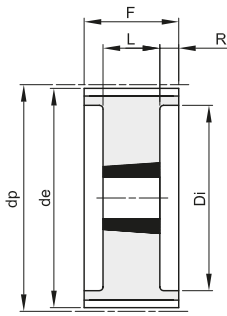

18

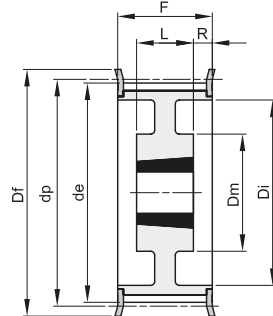

19F

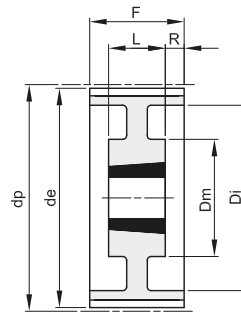

19

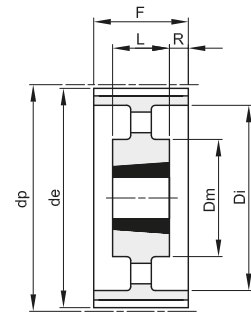

20

Materiale: Acciaio (St)
Materiale: Ghisa (GG)

descrizione	codice	tipo	materiale	denti	buss.	foro max	dp	de	Df	Dm	Di	F	L	R	d	n° flangia	Kg.
8M 30S 62	PCB47062030	2F	St	30			76,39	74,79	83	62		72	84	15	314	2,40	
8M 32S 62	PCB47062032	2F	St	32			81,49	79,89	87	65		72	84	15	315	2,80	
8M 34S 62	PCB47062034	2F	St	34			86,58	84,98	91	70		72	84	15	316	3,00	
8M 36S 62	PCB47062036	2F	St	36			91,67	90,07	98	75		72	84	15	319	3,40	
8M 38S 62	PCB47062038	2F	St	38			96,77	95,17	103	75		72	84	15	320	3,80	
TL 8M 40S 62	PCB47062040	15F	St	40	2012	50	101,86	100,26	106			72				321	2,06
TL 8M 45S 62	PCB47062045	15F	St	45	2012	50	114,59	112,99	119			72				325	3,00
TL 8M 48S 62	PCB47062048	15F	St	48	2517	65	122,23	120,63	127			72				327	2,90
TL 8M 50S 62	PCB47062050	15F	St	50	2517	65	127,32	125,72	135			72				328	3,25
TL 8M 56S 62	PCB47062056	19F	St	56	2517	65	142,60	141,00	148		111	72	45	13,5		333	3,90
TL 8M 60S 62	PCB47062060	19F	St	60	2517	65	152,79	151,19	158		121	72	45	13,5		335	4,70
TL 8M 64S 62	PCB47062064	19F	St	64	2517	65	162,97	161,37	168		131	72	45	13,5		338	5,60
TL 8M 75S 62	PCB47062075	18	GG	75	3020	75	190,99	189,39			159	72	51	10,5			7,50
TL 8M 80S 62	PCB47062080	18	GG	80	3020	75	203,72	202,12			172	72	51	10,5			9,20
TL 8M 90S 62	PCB47062090	18	GG	90	3020	75	229,18	227,58			197	72	51	10,5			7,70
TL 8M 112S 62	PCB47062112	19	GG	112	3020	75	285,21	283,61		150	253	72	51	10,5			12,10
TL 8M 140S 62	PCB47062140	19	GG	140	3525	90	356,51	354,91		198	324	72	65	3,5			22,70
TL 8M 168S 62	PCB47062168	20	GG	168	3525	90	427,81	426,21		198	396	72	65	3,5			26,80
TL 8M 192S 62	PCB47062192	20	GG	192	3525	90	488,92	487,32		198	457	72	65	3,5			34,20



PULEGGE DENTATE "PCB" A BUSSOLA CONICA PER CINGHIE SYNCHROCHAIN "PCB" SYNCHROCHAIN TIMING BELTS PULLEYS FOR TAPER BUSHES

14M

PASSO 14 mm

PER CINGHIE LARGHEZZA 20 mm

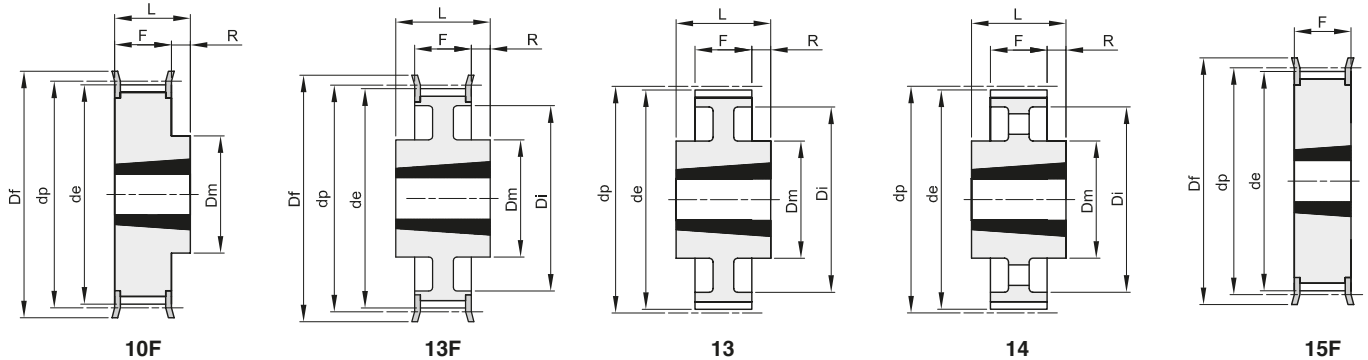

Materiale: Acciaio (St)
Materiale: Ghisa (GG)

descrizione	codice	tipo	materiale	denti	buss.	foro max	dp	de	Df	Dm	Di	F	L	R	d	n° flangia	Kg.
TL 14M 28S 20	PCB48020028	15F	St	28	2012	50	124,78	121,98	127			33				400	1,66
TL 14M 30S 20	PCB48020030	15F	St	30	2012	50	133,69	130,89	138			33				401	2,20
TL 14M 32S 20	PCB48020032	15F	St	32	2012	50	142,60	139,80	154			33				403	3,20
TL 14M 34S 20	PCB48020034	10F	St	34	2517	65	151,52	148,72	160	117		33	45	12		404	3,00
TL 14M 36S 20	PCB48020036	10F	St	36	2517	65	160,43	157,63	168	117		33	45	12		405	3,60
TL 14M 38S 20	PCB48020038	10F	St	38	2517	65	169,34	166,54	183	117		33	45	12		406	4,00
TL 14M 40S 20	PCB48020040	10F	St	40	2517	65	178,25	175,45	188	117		33	45	12		407	4,70
TL 14M 44S 20	PCB48020044	10F	St	44	3020	75	196,08	193,28	211	144		33	51	18		411	5,60
TL 14M 48S 20	PCB48020048	10F	St	48	3020	75	213,90	211,11	226	144		33	51	18		412	6,80
TL 14M 50S 20	PCB48020050	10F	GG	50	3020	75	222,82	220,02	240	144		33	51	18		414	7,70
TL 14M 56S 20	PCB48020056	13F	GG	56	3020	75	249,55	246,76	256	144	207	33	51	9		416	7,70
TL 14M 60S 20	PCB48020060	13	GG	60	3020	75	267,38	264,58		159	224	33	51	9			8,50
TL 14M 64S 20	PCB48020064	13	GG	64	3020	75	285,21	282,41		159	242	33	51	9			10,20
TL 14M 72S 20	PCB48020072	13	GG	72	3020	75	320,86	318,06		159	278	33	51	9			11,50
TL 14M 80S 20	PCB48020080	13	GG	80	3020	75	356,51	353,71		159	314	33	51	9			13,50
TL 14M 90S 20	PCB48020090	14	GG	90	3020	75	401,07	398,27		159	360	33	51	9			14,20
TL 14M 112S 20	PCB48020112	14	GG	112	3020	75	499,11	496,31		159	456	33	51	9			18,10
TL 14M 140S 20	PCB48020140	14	GG	140	3020	75	623,89	621,09		159	581	33	51	9			22,90



PULEGGE DENTATE "PCB" A BUSSOLA CONICA PER CINGHIE SYNCHROCHAIN "PCB" SYNCHROCHAIN TIMING BELTS PULLEYS FOR TAPER BUSHES

14M

PASSO 14 mm

PER CINGHIE LARGHEZZA 37 mm

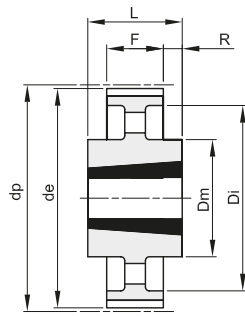

14

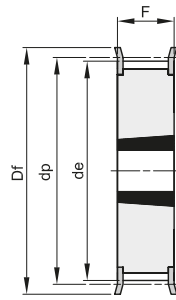

15F

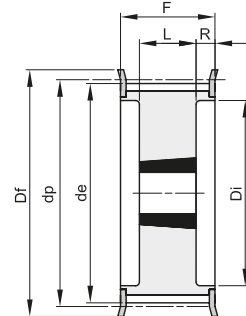

18F

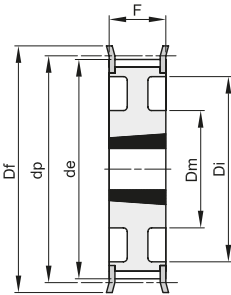

21F

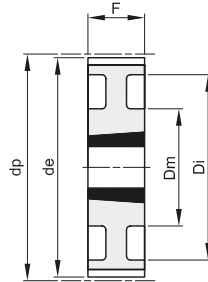

21

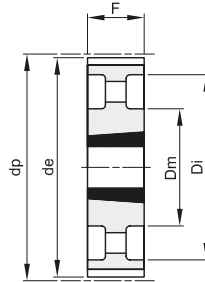

22

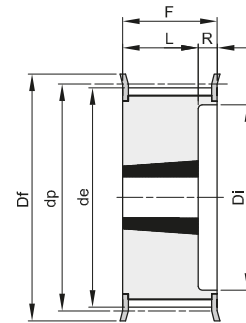

23F

Materiale: Acciaio (St)
Materiale: Ghisa (GG)

descrizione	codice	tipo	materiale	denti	buss.	foro max	dp	de	Df	Dm	Di	F	L	R	d	n° flangia	Kg.
TL 14M 28S 37	PCB48037028	23F	St	28	2012	50	124,78	121,98	127		88	51	32	19		400	2,20
TL 14M 30S 37	PCB48037030	18F	St	30	2517	65	133,69	130,89	138		98	51	45	3		401	2,50
TL 14M 32S 37	PCB48037032	18F	St	32	2517	65	142,60	139,80	154		100	51	45	3		403	3,00
TL 14M 34S 37	PCB48037034	18F	St	34	2517	65	151,52	148,72	160		109	51	45	3		404	3,80
TL 14M 36S 37	PCB48037036	23F	St	36	2517	65	160,43	157,63	168		117	51	45	6		405	4,30
TL 14M 38S 37	PCB48037038	23F	St	38	2517	65	169,34	166,54	183		126	51	45	6		406	5,10
TL 14M 40S 37	PCB48037040	23F	St	40	2517	65	178,25	175,45	188		135	51	45	6		407	6,00
TL 14M 44S 37	PCB48037044	15F	St	44	3020	75	196,08	193,28	211			51				411	7,00
TL 14M 48S 37	PCB48037048	15F	St	48	3020	75	213,90	211,11	226			51				412	9,00
TL 14M 50S 37	PCB48037050	15F	GG	50	3020	75	222,82	220,02	240			51				414	10,00
TL 14M 56S 37	PCB48037056	21F	GG	56	3020	75	249,55	246,76	256	144	207	51				416	9,20
TL 14M 60S 37	PCB48037060	21	GG	60	3020	75	267,38	264,58		159	224	51					10,20
TL 14M 64S 37	PCB48037064	21	GG	64	3020	75	285,21	282,41		159	242	51					12,20
TL 14M 72S 37	PCB48037072	21	GG	72	3020	75	320,86	318,06		159	278	51					13,40
TL 14M 80S 37	PCB48037080	21	GG	80	3020	75	356,51	353,71		159	314	51					16,10
TL 14M 90S 37	PCB48037090	22	GG	90	3020	75	401,07	398,27		159	360	51					17,20
TL 14M 112S 37	PCB48037112	22	GG	112	3020	75	499,11	496,31		159	456	51					23,00
TL 14M 140S 37	PCB48037140	14	GG	140	3525	90	623,89	621,09		206	581	51	65	7			41,00
TL 14M 168S 37	PCB48037168	14	GG	168	3525	90	748,66	745,87		206	706	51	65	7			51,50
TL 14M 192S 37	PCB48037192	14	GG	192	4030	90	855,61	852,82		215	812	51	76	12,5			60,00



PULEGGE DENTATE "PCB" A BUSSOLA CONICA PER CINGHIE SYNCHROCHAIN "PCB" SYNCHROCHAIN TIMING BELTS PULLEYS FOR TAPER BUSHES

14M

PASSO 14 mm

PER CINGHIE LARGHEZZA 68 mm

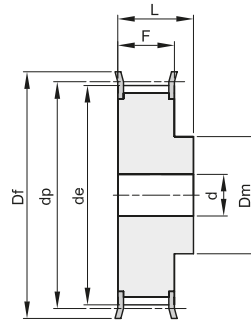

2F

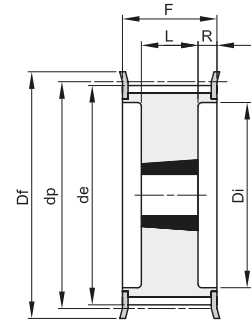

18F

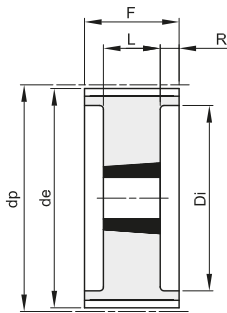

18

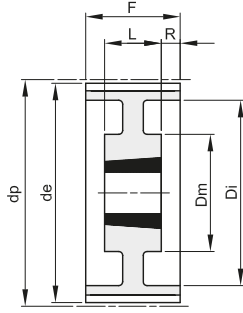

19

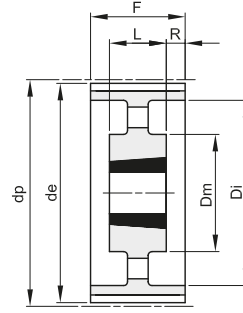

20

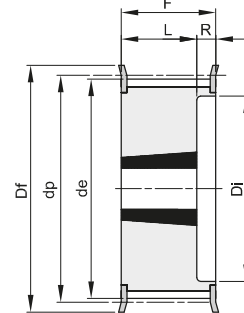

23F

Materiale: Acciaio (St)
Materiale: Ghisa (GG)

descrizione	codice	tipo	materiale	denti	buss.	foro max	dp	de	Df	Dm	Di	F	L	R	d	n° flangia	Kg.
14M 34S 68	PCB48068034	2F	St	34			151,52	148,72	160	131		84	104	32	404	10,50	
14M 36S 68	PCB48068036	2F	St	36			160,43	157,63	168	131		84	104	32	405	11,70	
14M 38S 68	PCB48068038	2F	St	38			169,34	166,54	183	141		84	104	32	406	13,40	
14M 40S 68	PCB48068040	2F	St	40			178,25	175,45	188	155		84	104	32	407	15,40	
TL 14M 44S 68	PCB48068044	18F	St	44	3020	75	196,08	193,28	211		153	84	51	16,5		411	9,20
TL 14M 48S 68	PCB48068048	23F	St	48	3020	75	213,90	211,11	226		171	84	51	33		412	11,30
TL 14M 50S 68	PCB48068050	18F	GG	50	3525	90	222,82	220,02	240		180	84	65	9,5		414	15,50
TL 14M 56S 68	PCB48068056	18F	GG	56	3525	90	249,55	246,76	256		207	84	65	9,5		416	16,80
TL 14M 60S 68	PCB48068060	18	GG	60	3525	90	267,38	264,58			224	84	65	9,5			20,40
TL 14M 64S 68	PCB48068064	18	GG	64	3525	90	285,21	282,41			242	84	65	9,5			23,60
TL 14M 72S 68	PCB48068072	19	GG	72	3525	90	320,86	318,06		178	278	84	65	9,5			20,30
TL 14M 80S 68	PCB48068080	20	GG	80	3525	90	356,51	353,71		178	314	84	65	9,5			21,30
TL 14M 90S 68	PCB48068090	20	GG	90	3525	90	401,07	398,27		178	360	84	65	9,5			24,40
TL 14M 112S 68	PCB48068112	20	GG	112	3525	90	499,11	496,31		178	456	84	65	9,5			32,70
TL 14M 140S 68	PCB48068140	20	GG	140	3525	90	623,89	621,09		206	581	84	65	9,5			55,00
TL 14M 168S 68	PCB48068168	20	GG	168	3525	90	748,66	745,87		206	706	84	65	9,5			71,00
TL 14M 192S 68	PCB48068192	20	GG	192	4030	90	855,61	852,82		215	812	84	76	4			80,50



PULEGGE DENTATE "PCB" A BUSSOLA CONICA PER CINGHIE SYNCHROCHAIN "PCB" SYNCHROCHAIN TIMING BELTS PULLEYS FOR TAPER BUSHES

14M

PASSO 14 mm

PER CINGHIE LARGHEZZA 90 mm

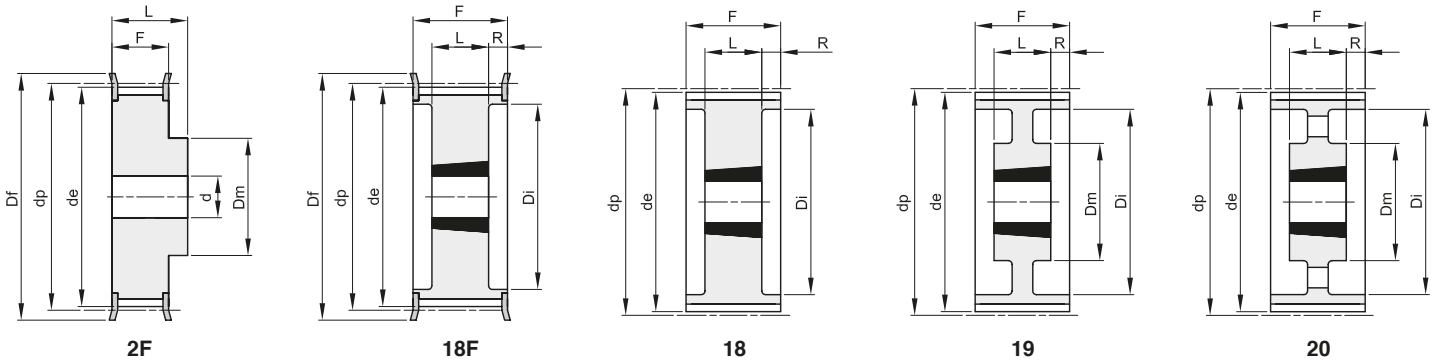

Materiale: Acciaio (St)
Materiale: Ghisa (GG)

descrizione	codice	tipo	materiale	denti	buss.	foro max	dp	de	Df	Dm	Di	F	L	R	d	n° flangia	Kg.
14M 36S 90	PCB48090036	2F	St	36			160,43	157,63	168	131		106	136		32	405	14,5
14M 38S 90	PCB48090038	2F	St	38			169,34	166,54	183	141		106	136		32	406	17,5
14M 40S 90	PCB48090040	2F	St	40			178,25	175,45	188	155		106	136		32	407	19,1
14M 44S 90	PCB48090044	2F	St	44			196,08	193,28	211	167		106	136		32	411	23,9
TL 14M 48S 90	PCB48090048	18F	St	48	3525	90	213,90	211,11	226		171	106	66	20		412	12,7
TL 14M 50S 90	PCB48090050	18F	GG	50	3525	90	222,82	220,02	240		180	106	66	20		414	14,5
TL 14M 56S 90	PCB48090056	18F	GG	56	3525	90	249,55	246,76	256		207	106	66	20		416	19,0
TL 14M 60S 90	PCB48090060	18	GG	60	3525	90	267,38	264,58			224	106	66	20			22,5
TL 14M 64S 90	PCB48090064	18	GG	64	3525	90	285,21	282,41			242	106	66	20			24,0
TL 14M 72S 90	PCB48090072	19	GG	72	3525	90	320,86	318,06		178	278	106	66	20			22,6
TL 14M 80S 90	PCB48090080	19	GG	80	4030	90	356,51	353,71		215	314	106	76	15			27,0
TL 14M 90S 90	PCB48090090	19	GG	90	4030	90	401,07	398,27		215	360	106	76	15			34,1
TL 14M 112S 90	PCB48090112	20	GG	112	4535	120	499,11	496,31		215	456	106	90	8			46,0
TL 14M 140S 90	PCB48090140	20	GG	140	4535	120	623,89	621,09		215	581	106	90	8			61,0
TL 14M 168S 90	PCB48090168	20	GG	168	5040	125	748,66	745,87		267	706	106	102	2			90,0
TL 14M 192S 90	PCB48090192	20	GG	192	5040	125	855,61	852,82		267	812	106	102	2			108,5



PULEGGE DENTATE "PCB" A BUSSOLA CONICA PER CINGHIE SYNCHROCHAIN "PCB" SYNCHROCHAIN TIMING BELTS PULLEYS FOR TAPER BUSHES

14M

PASSO 14 mm

PER CINGHIE LARGHEZZA 125 mm

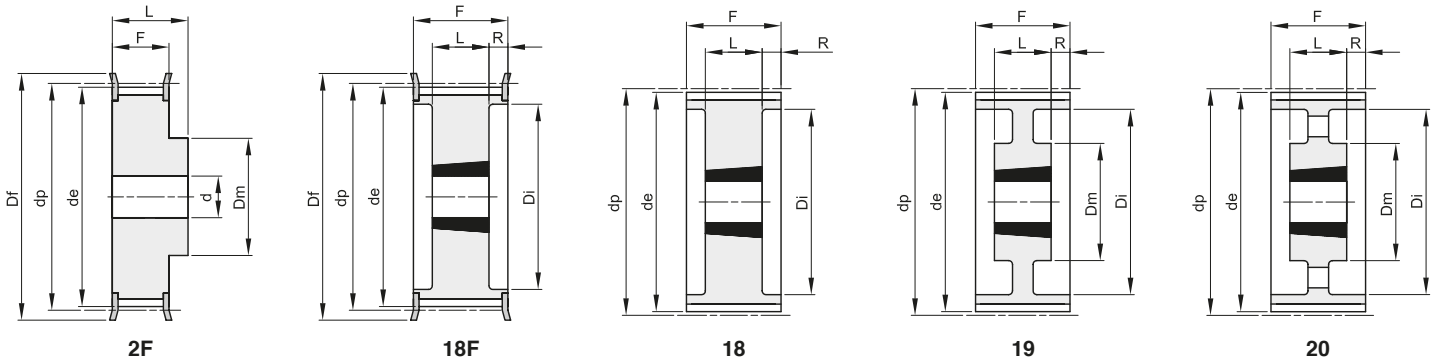

Materiale: Acciaio (St)
Materiale: Ghisa (GG)

descrizione	codice	tipo	materiale	denti	buss.	foro max	dp	de	Df	Dm	Di	F	L	R	d	n° flangia	Kg.
14M 38S 125	PCB48125038	2F	St	38			169,34	166,54	183	141		141	161		32	406	20,3
14M 40S 125	PCB48125040	2F	St	40			178,25	175,45	188	155		141	161		32	407	23,0
14M 44S 125	PCB48125044	2F	St	44			196,08	193,28	211	167		141	161		32	411	28,8
14M 48S 125	PCB48125048	2F	St	48			213,90	211,11	226	185		141	161		32	412	34,6
TL 14M 50S 125	PCB48125050	18F	GG	50	3525	90	222,82	220,02	240		180	141	65	38		414	16,8
TL 14M 56S 125	PCB48125056	18F	GG	56	3525	90	249,55	246,76	256		207	141	65	38		416	21,6
TL 14M 60S 125	PCB48125060	18	GG	60	4030	90	267,38	264,58			224	141	76	32,5			25,6
TL 14M 64S 125	PCB48125064	18	GG	64	4030	90	285,21	282,41			242	141	76	32,5			29,7
TL 14M 72S 125	PCB48125072	19	GG	72	4030	90	320,86	318,06		215	278	141	76	32,5			30,0
TL 14M 80S 125	PCB48125080	19	GG	80	4030	90	356,51	353,71		215	314	141	76	32,5			33,4
TL 14M 90S 125	PCB48125090	19	GG	90	4030	90	401,07	398,27		215	360	141	76	32,5			39,4
TL 14M 112S 125	PCB48125112	20	GG	112	4535	120	499,11	496,31		215	456	141	89	26			56,0
TL 14M 140S 125	PCB48125140	20	GG	140	4535	120	623,89	621,09		215	581	141	89	26			73,0
TL 14M 168S 125	PCB48125168	20	GG	168	5040	125	748,66	745,87		267	706	141	102	19,5			101,0
TL 14M 192S 125	PCB48125192	20	GG	192	5040	125	855,61	852,82		267	802	141	102	19,5			121,5